



ZEBRA ZKDU™

User's Guide

Zebra Keyboard Display Unit

© 2013 ZIH Corp. The copyrights in this manual and the software and/or firmware in the label printer and accessories described therein are owned by ZIH Corp. Unauthorized reproduction of this manual or the software and/or firmware in the label printer may result in imprisonment of up to one year and fines of up to \$10,000 (17 U.S.C.506). Copyright violators may be subject to civil liability.

This product may contain ZPL[®], ZPL II[®], and ZebraLink[™] programs; Element Energy Equalizer[®] Circuit; E³[®]; and Monotype Imaging fonts. Software © ZIH Corp. All rights reserved worldwide.

ZebraLink and all product names and numbers are trademarks, and Zebra, the Zebra logo, ZPL, ZPL II, Element Energy Equalizer Circuit, and E³ Circuit are registered trademarks of ZIH Corp. All rights reserved worldwide.

All other brand names, product names, or trademarks belong to their respective holders. For additional trademark information, please see “Trademarks” on the Zebra website.

Proprietary Statement This manual contains proprietary information of Zebra Technologies Corporation and its subsidiaries (“Zebra Technologies”). It is intended solely for the information and use of parties operating and maintaining the equipment described herein. Such proprietary information may not be used, reproduced, or disclosed to any other parties for any other purpose without the express, written permission of Zebra Technologies.

Product Improvements Continuous improvement of products is a policy of Zebra Technologies. All specifications and designs are subject to change without notice.

Liability Disclaimer Zebra Technologies takes steps to ensure that its published Engineering specifications and manuals are correct; however, errors do occur. Zebra Technologies reserves the right to correct any such errors and disclaims liability resulting therefrom.

Limitation of Liability In no event shall Zebra Technologies or anyone else involved in the creation, production, or delivery of the accompanying product (including hardware and software) be liable for any damages whatsoever (including, without limitation, consequential damages including loss of business profits, business interruption, or loss of business information) arising out of the use of, the results of use of, or inability to use such product, even if Zebra Technologies has been advised of the possibility of such damages. Some jurisdictions do not allow the exclusion or limitation of incidental or consequential damages, so the above limitation or exclusion may not apply to you.

FCC Compliance Statement (USA)

This device complies with Part 15 rules. Operation is subject to the following two conditions:

1. This device may not cause harmful interference, and
2. This device must accept any interference received, including interference that may cause undesired operation.

This equipment has been tested and found to comply with the limits for Class B Digital Devices, pursuant to Part 15 of the FCC Rules. These limits are designed to provide reasonable protection against harmful interference when the equipment is operated in a residential environment. This equipment generates, uses, and can radiate radio frequency energy and, if not installed and used in accordance with the product manuals, may cause harmful interference to radio communications. However, there is no guarantee that interference will not occur in a particular installation. If this equipment does cause harmful interference to radio or television reception, the user is encouraged to do one or more of the following measures:

- Reorient or relocate the receiving antenna.
- Increase the separation between the equipment and receiver.
- Connect the equipment into an outlet on a circuit different from that to which the receiver is connected.
- Consult the dealer or an experienced RF service technician for help.

The user is cautioned that any changes or modifications not expressly approved by Zebra Technologies could void the user's authority to operate the equipment. To ensure compliance, this printer must be used with fully shielded communication cables.

Canadian DOC Compliance Statement

This Class B digital apparatus complies with Canadian ICES-003.
Cet appareil numérique de la classe B est conforme à la norme NMB-003 du Canada.

Environmental Management



Do not dispose of this product in unsorted municipal waste. This product is recyclable, and should be recycled according to your local standards.

For more information, please see our website at:

Web address: www.zebra.com/environment

Related Documents

The following documents might be helpful references:

- *ZPL II[®] Programming Guide*
- *EPL[™] Programmer's Manual*

Document Conventions

The following conventions are used throughout this document to convey certain information:

Alternate Color (online only) Cross-references contain links to other sections in this guide. If you are viewing this guide online, click the [blue text](#) to jump to its location.

Command Line Examples All command line examples appear in `Courier New` font. For example, type the following to get to the Post-Install scripts in the `bin` directory:

```
Ztools
```

Files and Directories All file names and directories appear in `Courier New` font. For example, the `<version number>.tar` file and the `/root` directory.

Icons Used



Caution • Warns you of a potential electric shock situation.



Caution • Advises you that failure to take or avoid a specific action could result in physical harm to you.



Important • Advises you of information that is essential to complete a task.



Note • Indicates neutral or positive information that emphasizes or supplements important points of the main text.

Contents

Environmental Management	iv
Related Documents	iv
Document Conventions	iv
• Contents	v
1 • Introduction	1
The Zebra Keyboard Display Unit	2
What's in the box?	3
Unpack and Inspect the ZKDU	3
Repacking the ZKDU	3
ZKDU Features	4
ZKDU Keyboard Controls	5
ZKDU Display	7
ZKDU Data Entry	8
Keyboard Data Entry	8
2 • Setup	9
Basic Hardware Installation	10
Setting the Printer Up	10
Configuring the Printer Serial Port	11
First Use - Testing the System	12
3 • EPL ZKDU System	15
Unique ZKDU EPL Features	16
Important EPL Commands for Operator Interactive Print Forms	16

- EPL Mode ZKDU Use Example 17
 - Printing Forms without Variables 17
 - Printing Forms with Variables 18
 - Printing Forms with Consecutive Number Fields 18
 - Forcing the Operator to Re-enter Variable Input Data 19
 - Protecting Operator Variable Input Data 19
- Configuring Language Locales for the ZKDU 20
 - Character Overlay Support by Country and Code Page 21
 - Programming the EPL Printer and ZKDU for Language and Locale 25
 - Adding the Keyboard Overlay to the ZKDU 26
 - Entering the Alternate Characters for Display and Print 26
- 4 • ZPL ZKDU System 27**
 - Unique ZKDU ZPL Features 28
 - ZKDU Internal Forms Processing Memory 29
 - ZPL Commands for Operator Interactive Print Forms 29
 - ZPL Mode ZKDU Operator Usage Examples 30
 - Printing Forms without Variables 30
 - Printing Forms with Variables 31
 - Printing Forms with Consecutive Number Fields 31
- 5 • Auxiliary Port 33**
 - The Auxiliary Port 34
 - Auxiliary Port Communication Configuration 34
 - ZKDU Pinout Configuration 34
- 6 • Dimensions 35**
 - ZKDU External DimensionsZKDU 36

Introduction

Thank you for choosing the Zebra Keyboard Display Unit (ZKDU). This manual guides you through setup and operation of the ZKDU.

Contents

The Zebra Keyboard Display Unit	2
What's in the box?	3
Unpack and Inspect the ZKDU	3
Repacking the ZKDU	3
ZKDU Features	4
ZKDU Keyboard Controls	5
ZKDU Display	7
ZKDU Data Entry	8
Keyboard Data Entry	8

The Zebra Keyboard Display Unit

The Zebra Keyboard Display Unit (ZKDU) is a terminal unit that interfaces with Zebra label printers in a standalone capacity.

The ZKDU is designed to print pre-stored forms (print layout formats) in Zebra label printers that support EPL (EPL2) or ZPL (ZPL II) label format programming languages. Some Zebra label printers have EPL (only), some ZPL (only), and some later model Zebra label printers that simultaneous support both ZPL and EPL printer languages. Depending upon the print form's format, the operator can be prompted via the form's data entry format and the ZKDU's form access and print controls to enter data, serial numbers, reprint quantity, and batch print quantities.

The ZKDU has sixty-two (62) keys and a 2-line, 20 character LCD display. The ZKDU is powered by and communicates with the printer through an RS232 serial port with a DB-9 (standard printers). The ZKDU includes a low current auxiliary serial port for attaching a scanner, scale or other peripheral devices. The ZKDU has been designed to interface with many Zebra label printers that support EPL2 and ZPL II Zebra printer programming languages.

The ZKDU is strictly a terminal and does not have the capability to store data or configure ZKDU or printer parameters. The ZKDU is used for the following functions:

- List label forms stored in printer
- Retrieve label forms stored in printer
- Input variable data
- Print labels
- Switching between EPL and ZPL to dual support both language form types that can be stored and printed in many of later model Zebra label printers

The ZKDU is designed as a direct replacement for the Zebra KDU (Keyboard Display Unit) and the KDU Plus as a functional replacement when operating in Forms mode. It does not support terminal, setup, or file modes of the KDU Plus. See the Zebra Website for the new, existing and legacy label printers supported by the ZKDU, KDU and KDU Plus keyboard display units.

The ZKDU features automatic printer configuration detection of:

- The Zebra label printer's serial port type (DTE or DCE). Eliminates the need for cable adapters used with some printer models and the KDU.
- The ZKDU tests and configures communications and forms processing to match the printer's default label printing language: EPL or ZPL.

The ZKDU has limited language locale support. It supports the EPL keyboard character variations based on the printer's language code page and region setting. For EPL forms, Zebra has included keyboard overlay strips for use with one of 14 different locales supported by the printer's EPL

For a list of Zebra label printers supported by the ZKDU, see the following Zebra Website page:

www.zebra.com/zkdu-info

What's in the box?

Save the carton and packing material in case you need to ship or store the ZKDU later. After unpacking, make sure you have all parts.

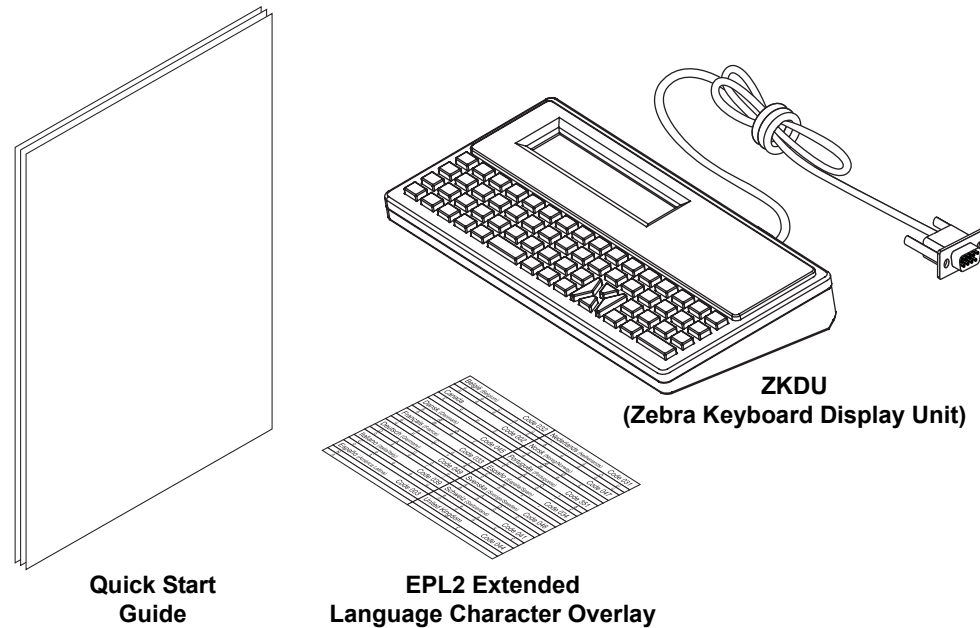

Unpack and Inspect the ZKDU

When you receive the ZKDU immediately unpack it and inspect for shipping damage.

- Save all packing materials.
- Check all exterior surfaces for damage.

If you discover shipping damage upon inspection:

- Immediately notify the shipping company and file a damage report. Zebra Technologies Corporation is not responsible for any damage to the ZKDU incurred during shipment, and will not cover the repair of this damage under its warranty policy.
- Keep all packaging material for shipping company inspection.
- Notify your authorized Zebra® reseller.

Repacking the ZKDU

1. Place the overlay and Quick Start guide into the bottom of the carton.
2. Place the ZKDU into the bubble wrap bag. Then wrap it in the sheet of bubble wrap and place it into the carton.
3. Seal and label the carton appropriately for shipment and receiving at its destination.
Note: Many companies (including Zebra) require an authorization number to receive material, such as, Zebra's RMA (Return Material Authorization) number.

ZKDU Features

The following shows the main functional features found on your ZKDU.

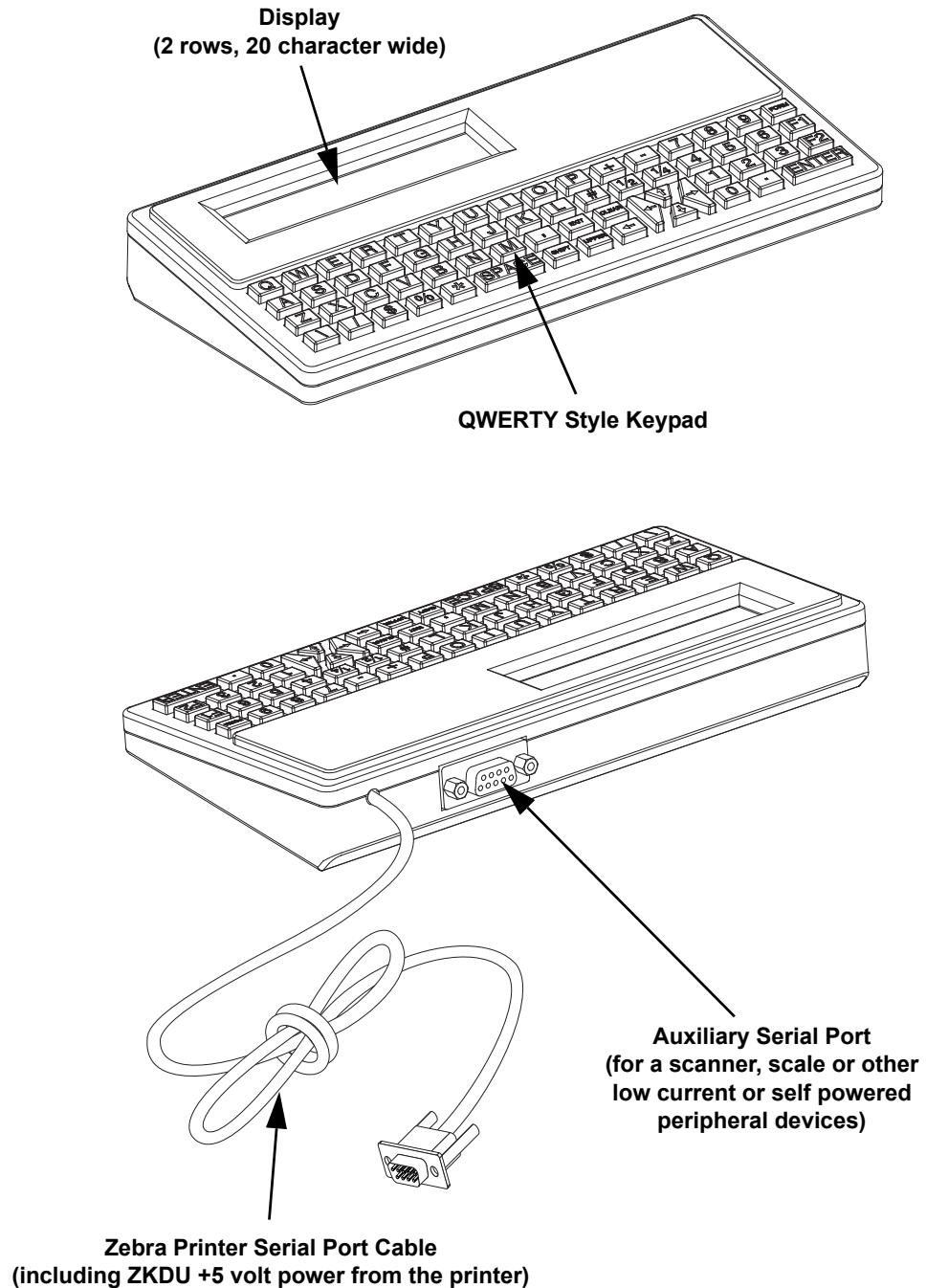

ZKDU Keyboard Controls

The ZKDU has a QWERTY style keyboard that includes special function and navigation keys to allow the operator to control form access, data entry, set print counts, and printing.

The white character keys are the valid characters allowed in form names for both EPL and ZPL formats. The white arrow keys are not valid characters, they are for navigation only.



After the ZKDU has finished its startup routine, the printer displays the FORM recall screen. The only keys that are active during this time are the **FORM**, **F1**, and **F2** keys.

```
Form - retrieve form
F2 - list forms EPL
```

FORM key - Print Form request. Pressing the “Form” key causes the ZKDU to display the forms request prompt. Valid Form names for the ZKDU are up to eight (8) characters long. The ZKDU will automatically append the appropriate extension for EPL or ZPL Form files based on the selected programming language mode of the ZKDU.

```
Enter form name:
█
```



Note • EPL form names are case sensitive, where ZPL form names are not.

F1 key - Select Printer/ZKDU Language. Prompts the user to change from the selected programming language to the other programming language (if available in your Zebra printer):

EPL to ZPL screen



ZPL to EPL screen

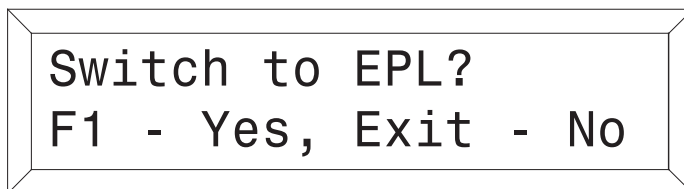

F2 key - Print a List of Forms. Pressing the “F2” key will cause the attached printer to print a list of forms that are stored in the printer. The list contain form names available to the ZKDU’s selected language mode: EPL or ZPL. See examples below.

EPL Forms Printout

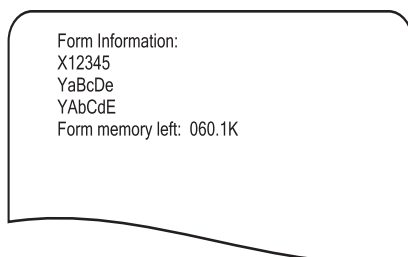

ZPL Forms Printout

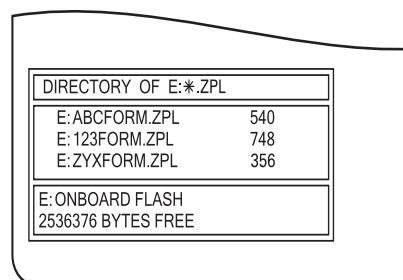

ENTER key - Press Enter key accept and send the form name, print count or other form fill-in data to the printer.

UPPER key - Toggles between Small and Capital letter modes during data input operations. This only changes white letter keys (and not the white number keys). This key does not effect data input via the Auxiliary port connected input device.



SHIFT key - Press the **SHIFT** key and one of the white letter keys to change the letter’s case (and not the white number keys). This key does not effect data input via the Auxiliary port connected input device.

← Backspace key - Deletes the character displayed to the immediate left of the cursor prompt (blinking block).

CLEAR key - Clears the data entry (the bottom displayed line) presently being entered.

EXIT key - Cancels present operation and returns the operator to the FORM recall screen.

 Navigation (white arrow) keys - The Navigation 'Arrow' keys (LEFT, RIGHT, UP, and DOWN) are used to navigate the displayed text.

- The  (UP and DOWN) arrow keys are **non-functional**.
- The  (LEFT and RIGHT) arrow keys move the data entry cursor through the buffered data (stored in temporary memory) to review or edit data prior to hitting the **ENTER** key.
- The arrow keys can move the cursor from the last character entered to the first character and back up to the maximum number of allowed characters in the data entry memory buffer (in second row of the displayed data). Characters can be replaced or deleted (with a backspace) from the position you navigated to using the  (LEFT and RIGHT) arrow keys. Note the display will only show nineteen (19) of the characters on the data buffer and the cursor.

ZKDU Display

The ZKDU display features:

- Two (2) lines of text (characters)
- Up to twenty (20) characters per line
- Prompt Data (first row): The first twenty (20) characters of prompt data sent by the active Form running in the attached Zebra printer.
- Data Entry (second row): Up to nineteen (19) characters and the cursor prompt (blinking block). Up to one-hundred and sixty (160) characters can be entered while displaying up to nineteen (19) characters. The operator can move the cursor prompt through all of the input data via the navigation arrow keys.

ZKDU Status and Mode Select Screens - The display shows up to two (2) lines of ZKDU status information or mode select prompts for changing the ZKDU's programming language mode.

Form Recall Screens - These screens are used to recall a form. The first line prompts the operator to enter the form name. The second line displays Form name the operator enters at the cursor prompt via the ZKDU keyboard or a peripheral device attached to the Auxiliary port on the ZKDU (i.e. scan gun, wedge device, etc.).

Data Entry and Form Recall Screens - These screens are used to recall a form and make data entries.

The first line contains up to the first twenty characters of form entry prompts. Any form (operator) prompt character that exceeds twenty (20) will not display even though the programming language may allow for more characters in the programming commands prompt parameter.

The second line will display operator entered data (keyboard or auxiliary port entered data). The number of data characters can not exceed one-hundred and sixty(160) characters.

ZKDU Data Entry

The ZKDU has three types of data entry and display data:

- ZKDU Keyboard
- Peripheral device attached to the Auxiliary port on the ZKDU (i.e. scan gun, wedge device, etc.).
- Zebra ZKDU compatible printer's Form interaction controls including operator messages (prompts, default values for printing, serial numbers, etc.) can interact and fill in data.

The maximum number of characters that can be entered from one data entry (prompt) is 160 characters. The display can only show 20 characters at one time. The  (LEFT and RIGHT) arrow keys are used to view and position the cursor (prompt). Data can be replaced or deleted where the cursor is positioned.

Keyboard Data Entry

The operator can enter

- A-Z, a-z, 1-9, \, /, \$, %, ½, ¼, *(asterisk), # (number sign), space (), comma (,), and period (.) are valid characters for use.
- EPL printers have the ability to interact with the ZKDU to change the language character code page and provides for different characters needed for data entry based upon language (code page) and locale (country) setting.

Setup

This section provides basic hardware setup for the Zebra label printer with ZKDU keyboard and an (integrator provided) optional low current peripheral device (barcode scanners, scales, etc.) for data input.

Contents

Basic Hardware Installation	10
Setting the Printer Up.	10
Configuring the Printer Serial Port	12
First Use - Testing the System	13

Basic Hardware Installation

The ZKDU has three (3) basic requirements for connecting and using a Zebra Label Printer with the ZKDU for the first time:

- ZKDU Compatible Zebra Label Printer - See the Zebra Website for a list. The ZKDU requires a fully functional Zebra label printer running EPL (EPL2), ZPL (ZPL II), or dual mode EZPL (EPL and ZPL) print operations.
- The Zebra label printer must have the Serial Port communications set to: **9600** baud, **8** bit word length, **NO** parity, **1** stop bit, and **Hardware (DTR/DSR)** data flow control.
- Compatible media for your Zebra label printer and your print job (the label forms you will print). See the printer's user and programmer manuals or guides for details about programming, Window's printer driver, and other tools available.

Setting the Printer Up

1. Connect the printer to power. With the printer power off, attach the printer to power. A Zebra TLP2824 Plus desktop label printer is shown for reference only. Your particular Zebra printer may have an internal power supply. See your users guide for more details.

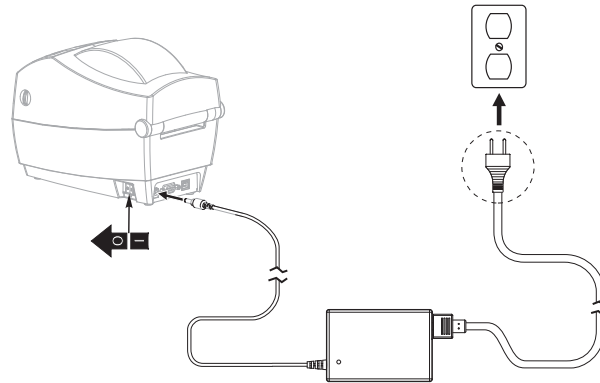

2. Connect your chosen Zebra label printer up to a PC with the Zebra Windows printer driver installed for your printer. Establish communication to the printer via one of the printer's other non-serial port interface connections, i.e. USB, parallel, Ethernet, etc. The serial port will be used for ZKDU operations.
3. Load your selected media in the printer. Use the Windows printer driver to set the media parameters and do a test print. The printer should be set for the media type and size in use, i.e. set it for continuous roll or label/tag/ticket with gap, notch or black mark/line. The media type and size (length and width) should be set and stored in the printer via appropriate programming commands or the Windows printer driver.



Note • Thermal transfer media requires ribbon to print, direct thermal media does not.

4. From here, Print Forms can be developed for storage to later be accessed and printed with the ZKDU in a stand alone capacity (not connection to PC or host computer).

Do not connect the ZKDU to the printer until the printer's serial port is configured.

Configuring the Printer Serial Port

Zebra label printers have a variety of different default serial port configurations and may have been modified by previous uses. If you are using a Windows based computer, the Zebra Setup Utility and ZDesigner Windows driver have various tools to allow you send files and commands to the printer.

1. Open the your Zebra label printer's Windows printer driver.
2. Open the Tools tab. Select 'Action' and 'Send command'.

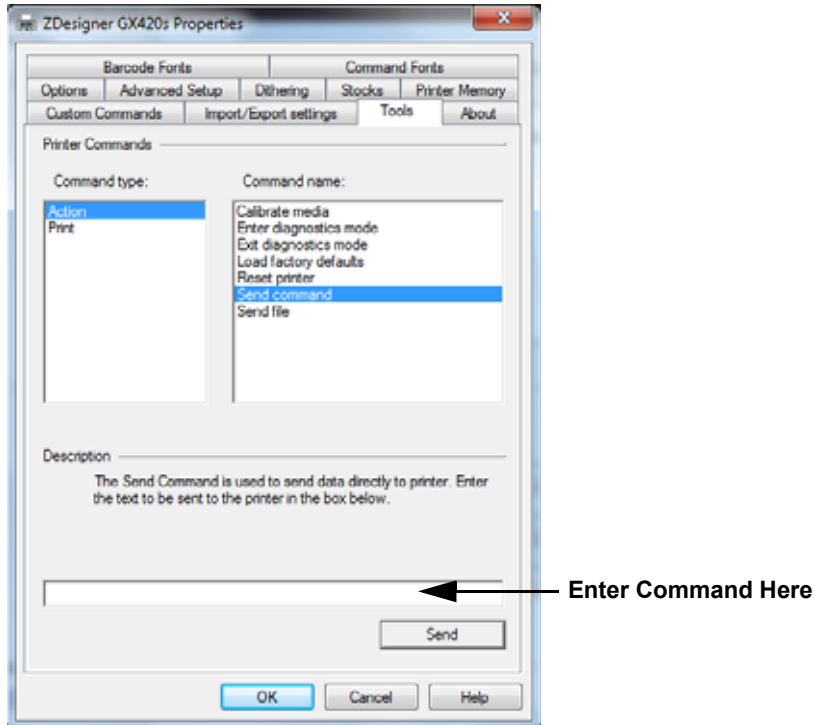

3. Enter one of the two (2) following command strings in the command input box and press the 'Send' button.

For EPL only printers:

Y9600,N,8,1

For ZPL and EZPL (EPL & ZPL dual mode) printers:

^SC9600,8,N,1,D,N^JUS

First Use - Testing the System

Lets review. We have:

- Setup the printer and configured it for your selected media.
- Performed a test print using the Windows printer driver.
- Set the printer's serial port for ZKDU communication.
- Optionally created one or more print forms and downloaded them into the printer.

The ZKDU and printer are now ready to be joined to become a stand alone print system. Use the following steps to complete the ZKDU print system's setup and print a list of the forms stored in the printer.

1. Turn the printer's power off.
2. Disconnect any other printer communication cables from the printer (used to configure printer and developpe print forms).
3. Connect the ZKDU serial cable to the printer's serial port and secure the cable with the thumb screws. (Printer shown for reference only, you may have a different model).

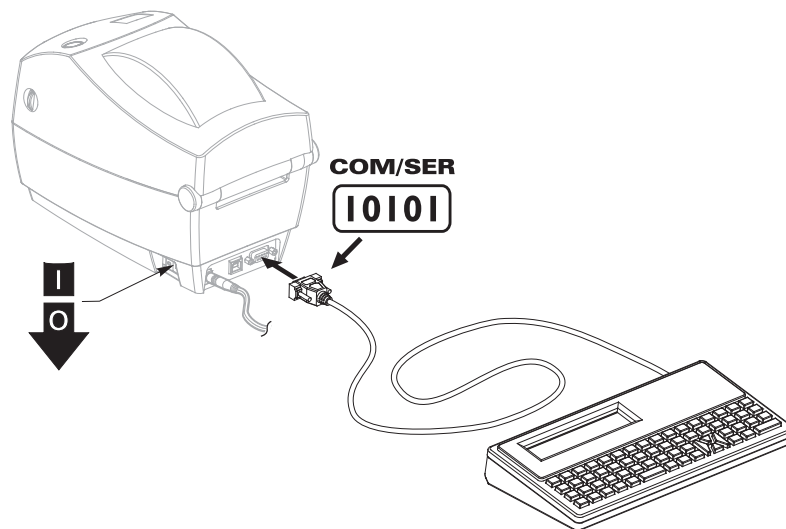

4. Turn the printer power on.

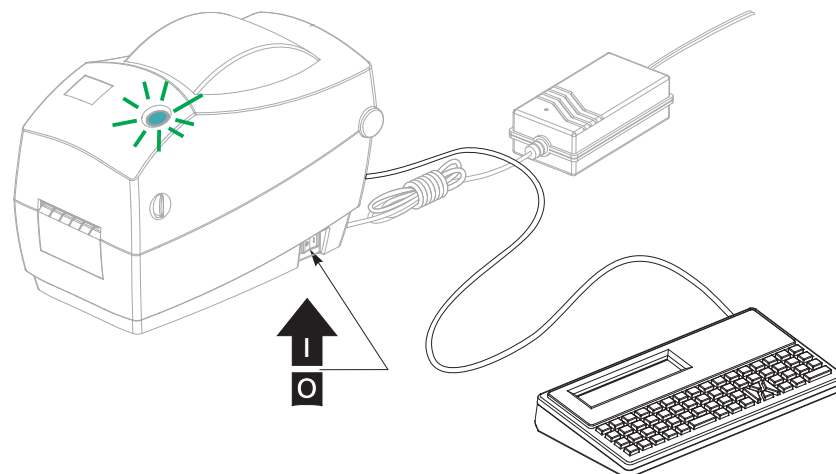

5. The ZKDU (and the attached printer) will begin initial internal testing. The ZKDU will then automatically detect the serial port configuration of the attached printer. The ZKDU finishes with testing for EPL print capability first, then tests for ZPL print capability, and if neither Zebra programming language is detected - an error message is displayed.

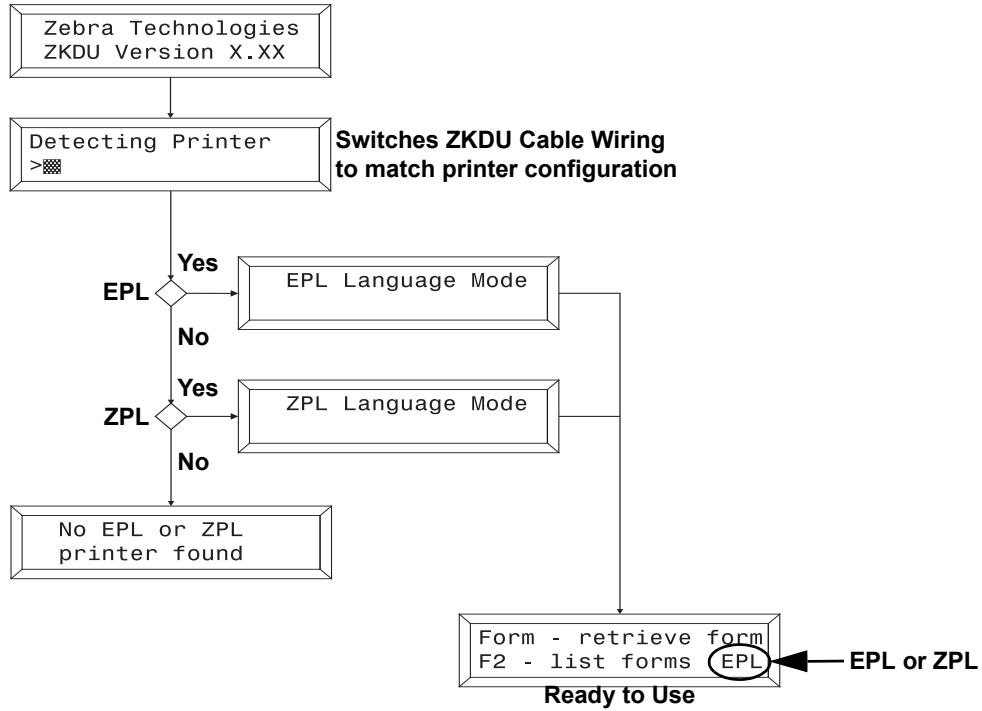

6. Press the **F2** key to print a list of Forms stored in the printer. See examples below.

EPL Forms Printout

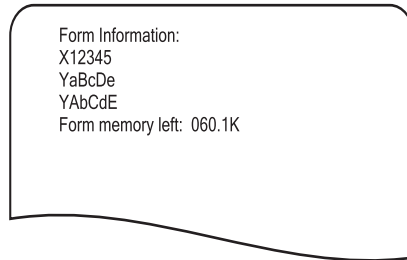

ZPL Forms Printout

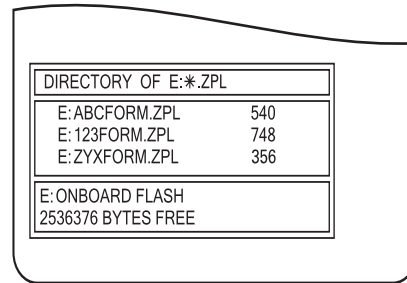

7. Some Zebra label printers support dual EPL and ZPL programming and can have both Form types present in printer memory. Use the **F1** key switch between language modes and then use the **F2** key to print a new list of Forms that design for the other programming language.

EPL ZKDU System

This chapter covers the unique features that a Zebra label printer operating with EPL programming exhibits when operating with the ZKDU.

Contents

Unique ZKDU EPL Features	16
Important EPL Commands for Operator Interactive Print Forms	16
EPL Mode ZKDU Use Example	17
Printing Forms without Variables	17
Printing Forms with Variables	18
Printing Forms with Consecutive Number Fields	18
Forcing the Operator to Re-enter Variable Input Data	19
Protecting Operator Variable Input Data	19
Configuring Language Locales for the ZKDU	20
ZKDU EPL Supported Language Code Pages	20
ZKDU EPL Supported Locales (Country Codes)	20
Character Overlay Support by Country and Code Page	21
Programming the EPL Printer and ZKDU for Language and Locale	25
Adding the Keyboard Overlay to the ZKDU	26
Entering the Alternate Characters for Display and Print	26

Unique ZKDU EPL Features

The ZKDU was designed to replace the original Zebra KDU. The KDU was designed to only operate with a Zebra label printer with the EPL programming language. All the form interaction was controlled by the printer and the form's unique programming. The EPL printer processes and passes only operator input data and prompts between it and the ZKDU. All form prompts and form data are stored in the printer (and by implication limited only by printer memory). The ZKDU duplicates the original KDU's operations.

The ZKDU operating in EPL mode:

- Form Names are case sensitive and are limited to 8 alpha-numeric characters. (ZPL form names are not case-sensitive).
- Supports up to 100 Variables, 10 (Numeric) Counter Variables, and unlimited use of the printer optional RTC (Real-Time Clock) Date and Time Variables.
- Starting values for counters can be set by ZKDU operator prompt. ZPL does not support this feature.
- The EPL prompt is limited to 40 characters, but only 20 characters can be displayed in the top row of the ZKDU display.
- The EPL enabled printer reserves a minimum of 3000 bytes (ASCII -non-hexadecimal) for storing operator responses to multi-copy form prompt replies. Each character is a byte. Legacy EPL printer models with cartridge memory have 1500 bytes as is documented in the EPL programmer's manual.
- A single print job can have up to 9999 unique print images (for serial number and operator input) with up to 9999 copies of each unique printed image. For example, you can print 3 copies of the same unique serial number label and print 5 sets of those serial number label copies for 15 total labels.
- Runs slightly faster and has fewer memory limitations than ZPL mode.
- Supports multiple language locales. The EPL enabled printer supports codepages and alternate keyboarding techniques to provide for language character and currency symbols variations for printing print formats designed for use in North and South America, and many European locales and languages. In contrast, the ZKDU only supports the ZPL enabled printer's default language locale codepage in ZPL mode. See [Configuring Language Locales for the ZKDU on page 20](#).

Important EPL Commands for Operator Interactive Print Forms

The following EPL commands can be used to add operator prompts and variable data to control print output with the ZKDU. See the EPL programmer's manual for details.

- **PA - Command:** Print Automatic - Controls print quantities (sets) and number of reprints (copies of each set member)
- **V - Command:** Define Variable - Creates data input variables and user prompts
- **C - Command:** Counter - Activates counter variables for sequencing numbers. Can be used as PA command parameters.
- **? - Command:** Download Variables - Listed here for reference. The ZKDU sends a Form Recall followed by this Download Variables command to begin operator prompts and data input. The **? - Command** is shown in several programming examples for other commands and can provide insight into the operation of the ZKDU.

EPL Mode ZKDU Use Example

Use the following steps to retrieve label form and produce labels with the printer and ZKDU.

1. **Start Up** - After the ZKDU has finished its startup routine, the printer displays the FORM recall screen.



```
Form - retrieve form
F2 - list forms EPL
```

2. **List of Saved Forms** - Press the **F2** key to print a list of saved forms.
3. **Retrieve a Form** - Press the **FORM** key. The top line in the display will prompt:

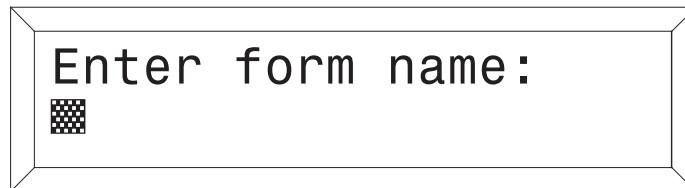

```
Enter form name:
█
```

Enter the Form name using the keys on the keyboard. Upper and lower case letters must match exactly as the form name was saved. Tip: If a scanner is connected to the ZKDU, you may enter the Form name by scanning it in from a pre-printed barcode.

When the Form name is entered, press **ENTER** to continue. The form is now retrieved and active in the printer.

Printing Forms without Variables

If the form does not contain variables, the display line will prompt:

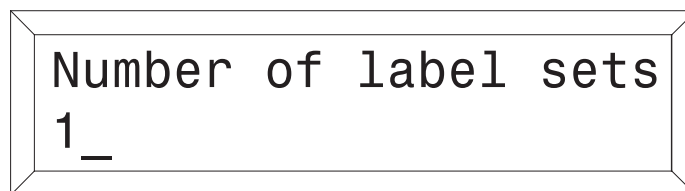

```
Number of label sets
1_
```

The default number of label sets is always one (1). Entering a different number(s) will overwrite the default value. Non numeric values will be ignored with an error beep. This prompt is supplied automatically by the ZKDU.

Single Label - If one (1) label is desired, press **ENTER** to print that label.

Multiple Labels - If multiple labels are desired, enter the new quantity and press **ENTER** to print labels.

Exit a Form - Press the **EXIT** key at any time to return to the Forms screen, or press the **FORM** key to select another form.

Printing Forms with Variables

If the Form contains variables, the display line will display the 1st variable prompt (as programmed 'Total No. of Boxes'), i.e.:

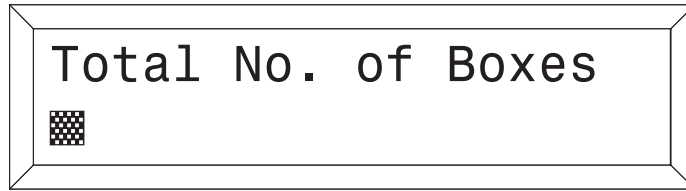

A rectangular form with a double-line border. The text "Total No. of Boxes" is centered at the top. Below the text is a small square icon with a grid pattern.

Enter data at each variable prompt and press **ENTER**. The final prompt is:

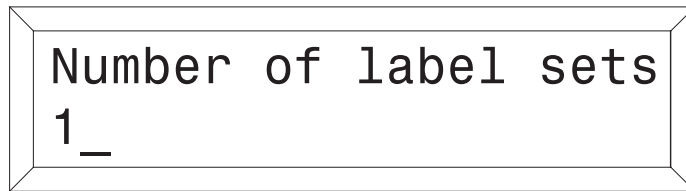

A rectangular form with a double-line border. The text "Number of label sets" is centered at the top. Below the text, the number "1" is followed by a horizontal line, indicating the current input.

The default number of label sets is always one (1). Entering a different number(s) will overwrite the default value. Non numeric values will be ignored with an error beep. This prompt is supplied automatically by the ZKDU.

Single Label - If one (1) label is desired, press **ENTER** to print that label.

Multiple Labels - If multiple labels are desired, enter the new quantity and press ENTER to print labels.

Exit a Form - Press the **EXIT** key at any time to return to the Forms screen, or press the **FORM** key to select another form.

Printing Forms with Consecutive Number Fields

If the Form contains a consecutive number (**C - Command:** Counter) field, the system will automatically keep track of the next number sequence. If you do not need to interfere with this predetermined sequence, press **ENTER** at this prompt. The final prompt is:

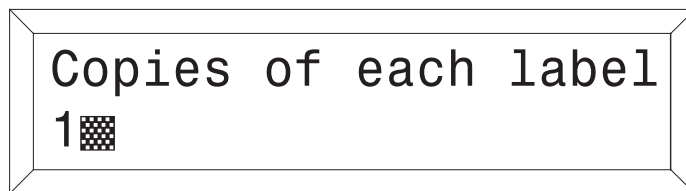

A rectangular form with a double-line border. The text "Copies of each label" is centered at the top. Below the text, the number "1" is followed by a small square icon with a grid pattern.

The default number of copies is always one (1). The default number of labels is always one (1). If one (1) copy is desired, press **ENTER** to print that label. Entering a different number(s) will overwrite the default value. Non numeric values will be ignored with an error beep. This prompt is supplied automatically by the ZKDU.

Note: Change the quantity if you desire multiple labels with the same consecutive number.

Edit Form Data - Once a Form has been activated, it will automatically indicate the last information keyed in. If you want to retain that information, press **ENTER**.

To Enter Data:

1. Enter the new input data, thereby overriding the previously entered input data for that variable, or
2. Press **ENTER** if the previously entered input data is correct, or
3. Use the orange  Backspace key or the **CLEAR** key to modify data. Enter new data at the cursor prompt and press **ENTER** to complete overwriting previous form data.

When you have finished editing and have printed the label, you will automatically return to the first variable prompt of this Form.

Exit a Form - Press the **EXIT** key at any time to return to the Forms screen, or press the **FORM** key to select another form.

Forcing the Operator to Re-enter Variable Input Data

If the operator prompt parameter has a 'Tilde' (~) character as the first character of the prompt string, then the input data (second line on the display) needs to be entered every time it is displayed. The 'Tilde' character does not display.

Protecting Operator Variable Input Data

If the operator prompt parameter has a 'Minus Sign' (-) character as the first character of the prompt string, then that data will be 'protected' and will not reappear until the Form has been exited and recalled from the printer as a new print job. The 'Minus Sign' character does not display when in the first position.

Configuring Language Locales for the ZKDU

The ZKDU supports printer language locale with the EPL alternate language select by A programming method to support character differences by locale. Character overlays are available to identify the changed characters for data entry. The default EPL language setting for language and locale support is Code Page 437 for English-USA. The ZKDU keyboard has been design to support this configuration. The ZKDU can support other languages and listed in this section.

The language settings for EPL printing operation is set with the **I - Command**. The ZKDU only supports printing and displaying with a subset of the languages and locales that the EPL print operations can support.

The **I - Command** structure matches the following:

I8 ,Code_Page ,Country_Code

The EPL printer default setting for language and locale setting is the equivalent of the following **I - Command** programming string:

I8 ,0 ,001

It is for the U.S. English Code Page 437 with the ZKDU/KDU country set for the USA (-001).

ZKDU EPL Supported Language Code Pages

The following code pages support both the ZKDU and EPL printers. Please reference the EPL Programming Guide to verify the character sets available for printing. The ZKDU supports data entry and displaying a large subset of each of these code pages.

Code Page	DOS Code Page	Language
0	437	English
1	850	Multilingual (Latin 1)
2	852	Slavic (Latin 2)
3	860	Portuguese
4	863	French Canadian
5	865	Nordic

ZKDU EPL Supported Locales (Country Codes)

Code	Country	Code	Country	Code	Country
001	USA	033	France	046	Sweden
002	Canada	034	Spain	047	Norway
003	Latin America	039	Italy	049	Germany
027	South Africa	041	Switzerland	351	Portugal
031	Netherlands	044	United Kingdom	358	Finland
032	Belgium	045	Denmark		

Character Overlay Support by Country and Code Page

The following tables show the combination of language code page and locale (country code) to change some of the characters to support use in various countries. The English (Code Page 437) characters in light blue row show the existing characters displayed on the two (2) overlay strips designed for each of the Country Code groups listed in the following tables of the six (6) language code page settings available for use with the ZKDU.

EPL2 Extended Language Character Overlay

België (Belgium)	Code 032	Nederlands (Netherlands)	Code 031
é è ç à ù		° : Å Ö Ü	
µ á ê î £		& ë ä ö ü	
Canada	Code 002	Norsk (Noreg/Norway)	Code 047
£ ¢ µ É		Å Æ Ø £	
		å æ ø	
Dansk (Denmark)	Code 045	Português (Portuguese)	Code 351
Å Æ Ø £		Ç Á Ö ª &	
å æ ø		ç á õ ° £	
Français (France)	Code 033	Español (España/Spain)	Code 034
é è Ç à £		Ç Ñ ª °	
ù µ ° = &		ç ñ ñ	
Deutsch (Germany)	Code 049	Svenska (Sverige/Sweden)	Code 046
Ö Å Ü ß µ		Å Ä Ö £	
ö å ü ()		ä ä ö	
Italiano (Italia/Italy)	Code 039	Schweiz (Switzerland)	Code 041
Ç é è à ù		é è à Ç £	
ò £		ö ü ä	
Español (América Latina)	Code 003	United Kingdom	Code 044
Ñ ñ			£

The **001** Country Code table does not require an overlay for data input. Note that when operating the EPL printer with the Slavic Code Page 852 set the ½ and ¼ characters will not print or display on the ZKDU.

Country Code	Code Page	Keyboard Key									
		+	-	7	8	9	½	¼	4	5	6
001 (USA)	English	+	-	7	8	9	½	¼	4	5	6
	Multilingual	+	-	7	8	9	½	¼	4	5	6
	Slavic	+	-	7	8	9			4	5	6
	Portuguese	+	-	7	8	9	½	¼	4	5	6
	Canadian	+	-	7	8	9	½	¼	4	5	6
	Nordic	+	-	7	8	9	½	¼	4	5	6

Country Code	Code Page	Keyboard Key									
		+	-	7	8	9	½	¼	4	5	6
002 (Canada)	English	£	¢	µ	É	9	½	¼	4	5	6
	Multilingual	£	¢	µ	É	9	½	¼	4	5	6
	Slavic	+	-	*	É	9			4	5	6
	Portuguese	£	¢	µ	É	9	½	¼	4	5	6
	Canadian	£	¢	µ	É	9	½	¼	4	5	6
	Nordic	£	-	4	É	9	½	¼	µ	5	6

Country Code	Code Page	Keyboard Key									
		+	-	7	8	9	½	¼	4	5	6
003 (Latin America)	English	Ñ	-	7	8	9	ñ	¼	4	5	6
	Multilingual	Ñ	-	7	8	9	ñ	¼	4	5	6
	Slavic	\$	-	7	8	9	/		4	5	6
	Portuguese	Ñ	-	7	8	9	ñ	¼	4	5	6
	Canadian	\$	-	7	8	9	/	¼	4	5	6
	Nordic	Ñ	-	7	8	9	ñ	¼	4	5	6

Country Code	Code Page	Keyboard Key									
		+	-	7	8	9	½	¼	4	5	6
031 (Netherlands)	English	°	:	Ä	Ö	Ü	&	ë	ä	ö	ü
	Multilingual	°	:	Ä	Ö	Ü	&	ë	ä	ö	ü
	Slavic	°	:	Ä	Ö	Ü	&	ë	ä	ö	ü
	Portuguese	°	:	7	8	Ü	&	¼	4	5	ü
	Canadian	°	:	7	8	Ü	&	ë	4	5	ü
	Nordic	°	:	Ä	Ö	Ü	&	ë	ä	ö	ü

Country Code	Code Page	Keyboard Key									
		+	-	7	8	9	½	¼	4	5	6
032 (Belgium)	English	é	è	ç	à	ù	µ	â	ê	î	£
	Multilingual	é	è	ç	à	ù	µ	â	ê	î	£
	Slavic	é	-	ç	8	9		â	4	î	6
	Portuguese	é	è	ç	à	ù	µ	â	ê	í	£
	Canadian	é	è	ç	à	ù	µ	â	ê	î	£
	Nordic	é	è	ç	à	ù	µ	â	ê	î	£

		Keyboard Key									
Country Code	Code Page	+	-	7	8	9	½	¼	4	5	6
033 (France)	English	é	è	Ç	à	£	ù	µ	°	=	&
	Multilingual	é	è	Ç	à	£	ù	µ	°	=	&
	Slavic	é	-	Ç	8	9			°	=	&
	Portuguese	é	è	Ç	à	£	ù	µ	°	=	&
	Canadian	é	è	Ç	à	£	ù	µ	°	=	&
	Nordic	é	è	Ç	à	£	ù	µ	°	=	&

		Keyboard Key									
Country Code	Code Page	+	-	7	8	9	½	¼	4	5	6
034 (Spain)	English	Ç	Ñ	^a	°	9	ç	ñ	4	5	6
	Multilingual	Ç	Ñ	^a	°	9	ç	ñ	4	5	6
	Slavic	Ç	-	7	8	9	ç		4	5	6
	Portuguese	Ç	Ñ	^a	°	9	ç	ñ	4	5	6
	Canadian	Ç	-	7	8	9	ç	¼	4	5	6
	Nordic	Ç	Ñ	^a	°	9	ç	ñ	4	5	6

		Keyboard Key									
Country Code	Code Page	+	-	7	8	9	½	¼	4	5	6
039 (Italy)	English	Ç	é	è	ä	ù	ò	£	4	5	6
	Multilingual	Ç	é	è	ä	ù	ò	£	4	5	6
	Slavic	Ç	é	7	8	9			4	5	6
	Portuguese	Ç	é	è	ä	ù	ò	£	4	5	6
	Canadian	Ç	é	è	ä	ù	½	£	4	5	6
	Nordic	Ç	é	è	ä	ù	ò	£	4	5	6

		Keyboard Key									
Country Code	Code Page	+	-	7	8	9	½	¼	4	5	6
041 (Switzerland)	English	é	è	à	Ç	£	ö	ü	ä	5	6
	Multilingual	é	è	à	Ç	£	ö	ü	ä	5	6
	Slavic	é	-	7	Ç	9	ö	ü	ä	5	6
	Portuguese	é	-	à	Ç	£	½	ü	4	5	6
	Canadian	é	è	à	Ç	£	½	ü	4	5	6
	Nordic	é	è	à	Ç	£	ö	ü	ä	5	6

		Keyboard Key									
Country Code	Code Page	+	-	7	8	9	½	¼	4	5	6
044 (U.K.) or 027 (South Africa)	English	+	-	7	8	9	½	¼	£	5	6
	Multilingual	+	-	7	8	9	½	¼	£	5	6
	Slavic	+	-	7	8	9			4	5	6
	Portuguese	+	-	7	8	9	½	¼	£	5	6
	Canadian	+	-	7	8	9	½	¼	£	5	6
	Nordic	+	-	7	8	9	½	¼	£	5	6

		Keyboard Key									
Country Code	Code Page	+	-	7	8	9	½	¼	4	5	6
045 (Denmark) or 047 (Norway)	English	À	Æ	*	£	9	à	æ	4	5	6
	Multilingual	À	Æ	Ø	£	9	å	æ	ø	5	6
	Slavic	+	-	7	8	9			4	5	6
	Portuguese	+	-	7	£	9	½	¼	4	5	6
	Canadian	+	-	7	£	9	½	¼	4	5	6
	Nordic	À	Æ	Ø	£	9	à	æ	ø	5	6

		Keyboard Key									
Country Code	Code Page	+	-	7	8	9	½	¼	4	5	6
046 (Sweden) or 358 (Finland)	English	À	Ä	Ö	£	9	à	ä	ö	5	6
	Multilingual	À	Ä	Ö	£	9	å	ä	ö	5	6
	Slavic	+	Ä	Ö	8	9		ä	ö	5	6
	Portuguese	+	-	7	£	9	½	¼	4	5	6
	Canadian	+	-	7	£	9	½	¼	4	5	6
	Nordic	À	Æ	Ö	£	9	à	æ	ö	5	6

		Keyboard Key									
Country Code	Code Page	+	-	7	8	9	½	¼	4	5	6
049 (Germany)	English	Ö	Ä	Ü	ß	µ	ö	ä	ü	()
	Multilingual	Ö	Ä	Ü	ß	µ	ö	ä	ü	()
	Slavic	Ö	Ä	Ü	ß	9	ö	ä	ü	()
	Portuguese	+	-	Ü	ß	µ	½	¼	ü	()
	Canadian	+	-	Ü	ß	µ	½	¼	ü	()
	Nordic	Ö	Ä	Ü	ß	µ	ö	ä	ü	()

Country Code	Code Page	Keyboard Key									
		+	-	7	8	9	½	¼	4	5	6
351 (Portugal)	English	Ç	-	7	a	&	ç	¼	4	°	£
	Multilingual	Ç	Ã	Õ	a	&	ç	ã	õ	°	£
	Slavic	Ç	-	7	8	&	ç		4	5	6
	Portuguese	Ç	Ã	Õ	a	&	ç	ã	õ	°	£
	Canadian	Ç	-	7	8	&	ç	¼	4	5	£
	Nordic	Ç	-	7	a	&	ç	¼	4	°	£

Programming the EPL Printer and ZKDU for Language and Locale

If you are using a Windows based computer, the Zebra Setup Utility and ZDesigner Windows driver have various tools to allow you send files and commands to the printer.

1. Open the your Zebra label printer’s Windows printer driver.
2. Open the Tools tab. Select ‘Action’ and ‘Send command’.

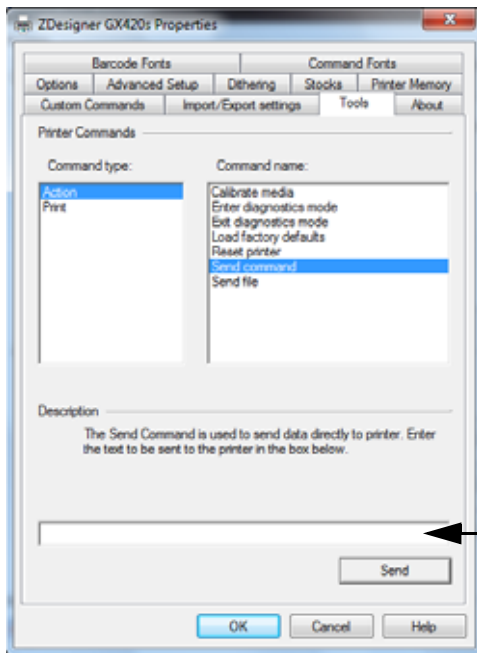

Enter Command Here

Enter a command string following the convention shown below in the command input box and press the ‘Send’ button.

I8, Code_Page, Country_Code

Replace the **CODE_PAGE** with a single digit Code Page number referenced in this section. See “ZKDU EPL Supported Language Code Pages” on page 20.

Replace the **COUNTRY_CODE** with a three digit Country Code number referenced in this section. See “ZKDU EPL Supported Locales (Country Codes)” on page 20.

Un-supported languages and locale configuration settings in the printer will be ignored by the ZKDU and the default to English Codepage 437 with Country code 001 for the USA locale.

Adding the Keyboard Overlay to the ZKDU

The ZKDU has fourteen (14) keyboard overlay strip pairs to support sixteen (16) language and locale (Country Code) settings in the EPL printer.

- Use the United Kingdom (Code **044**) strip pair for the South Africa (Code **041**) printer locale settings.
- Use the Sweden (Code **046**) strip pair for the Finland (Code **358**) printer locale settings.
- All other Country overlay pairs are marked on the overlay sheet.

Place the two character strips as shown below. The first strip gets placed above the top row starting at the 'plus' sign key. The second strip gets placed above the '1/2' character key.

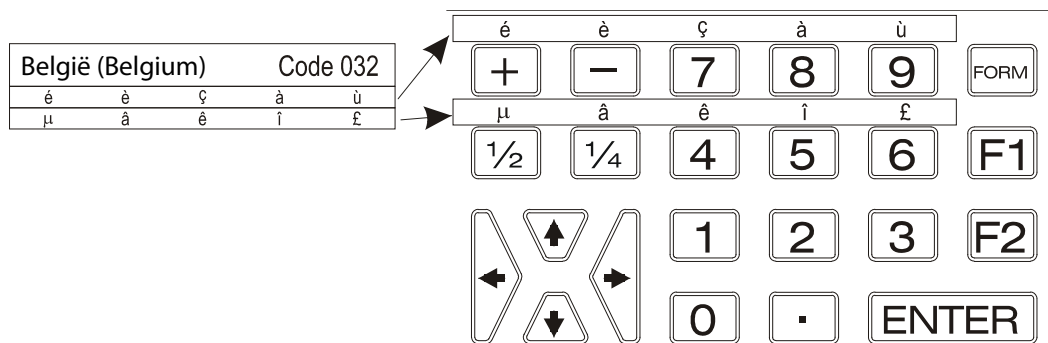

Entering the Alternate Characters for Display and Print

The operator can use the overlay to select the language/locale unique code page characters by pressing the key immediately below the desired overlay character while also pressing the shift key. For example, if the EPL printer has the language code page set to value '1' to support code page 850 for Multilingual (Latin 1) and the ZKDU country code set to '032' for Belgium, then by typing the 'Plus' sign (+) key immediately below the 'é' overlay character while pressing on the shift key, you will enter a 'é' into the data input and display it at the prompt on the ZKDU screen.

ZPL ZKDU System

This chapter covers the unique features that a Zebra label printer operating with ZPL programming exhibits when operating with the ZKDU.

Contents

Unique ZKDU ZPL Features	28
ZKDU Internal Forms Processing Memory	29
ZPL Commands for Operator Interactive Print Forms	29
ZPL Mode ZKDU Operator Usage Examples	30
Printing Forms without Variables	30
Printing Forms with Variables	31

Unique ZKDU ZPL Features

The ZKDU was designed to emulate the basic Form processing operations of the Zebra KDU Plus. ZPL Print Forms are imported and processed by the ZKDU. The ZPL form is parsed to extract operator data entry parameters and prompts. The ZKDU passes only operator input data to the printer to fill-in form variables. All form prompts and form input data are temporarily stored in the ZKDU while processing the recalled form.

The ZKDU operating in ZPL mode:

- ZPL Form Names are limited to 8 alpha-numeric characters and are not case sensitive. (EPL Form Names are case sensitive).
- ZPL Forms must be stored in the printer's E: memory to be accessed by the ZKDU.
- Supports Field Variables, Serial Number (Alpha-numeric Counter) Fields (not supported as a variable), and printer optional RTC (Real-Time Clock) Date and Time Variables.
- The ZPL prompt is limited to 255 characters, but only 20 characters can be displayed in the top row of the ZKDU display.
- 1024 bytes are reserved for ZPL form variables prompts and operator input data in the ZKDU. The KDU Plus only supported 576 bytes for this feature.
- A single print job can have up to 99,999,999 unique print images (for serial number and operator input) with up to 99,999,999 copies of each unique printed image. For example, you can print 3 copies of the same unique serial number label and print 5 sets of those serial number label copies for 15 total labels.
- Language and locale support is limited primarily to the lower half of the Zebra Codepage 850 (decimal 32-127), the printer's default character set. The ZKDU and printer in ZPL mode will display and print all the characters on the ZKDU keyboard. Data input made via a peripheral device (such as a scanner) attached to the ZKDU's auxiliary port or sent as form prompt data may not display correctly or will be replaced by a space.

ZKDU Internal Forms Processing Memory

The ZKDU has 1024 bytes reserved for ZPL form variables prompts and operator input data in the ZKDU. The memory is filled with operator prompts from one end and the operator responses to the prompts are stored starting at the opposite end. Form prompts get stored first, then as the form is run, the operator input data is sent to the printer and the ZKDU memory.

If the available memory for storing all of a form's variable and their prompts is exceeded, then it will display the following error message:

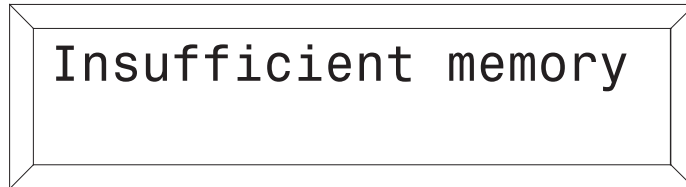

The total number of bytes used to store variables (and their prompts) of a ZPL form in the ZKDU is the total number of characters in the prompt plus seven bytes overhead. Each character is equal to a byte of data. If each prompt in a ZPL form were twenty (20) characters, then a total of 37 variables can be supported, i.e. $(20 + 7) \times 37 = 999$ bytes which is less than the 1024 max. bytes of ZKDU temporary form storage.

Left over memory from variable prompt (and pointer) storage is used for storing the operator input data (responses to prompts). This input data is used to pre-populate operator responses for subsequent form print entries. If 1024 bytes are exceeded during data entry, the ZKDU will clear the oldest previous value entered and continue the data entry process and store the new value. If the new value exceeds the storage limit, then the value will not be saved for the next iteration of the form.

ZPL Commands for Operator Interactive Print Forms

The following ZPL commands can be used to add operator prompts and variable data to control print output with the ZKDU.

- **^PQ - Command:** Print Quantity - Controls print quantities (sets) and number of reprints (copies of each set member)
- **^FN - Command:** Field Number - Identifies data input variables and provides user prompts
- **^SN - Command:** Serialization Data - Used to provide alpha-numeric incrementing or decrementing data fields. Starting index (count) values must be build into the form's format, it can not be added as a variable using the ^FN command.
- **^FV - Command:** Field Variable - Do Not Use In ZKDU Form. ^FV is designed for use with process chained forms.

ZPL Mode ZKDU Operator Usage Examples

Use the following steps to retrieve label form and produce labels with the printer and ZKDU.

1. **Start Up** - After the ZKDU has finished its startup routine, the printer displays the FORM recall screen.



2. **List of Saved Forms** - Press the **F2** key to print a list of saved forms.
3. **Retrieve a Form** - Press the **FORM** key. The top line in the display will prompt:

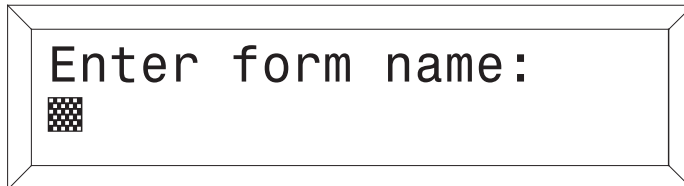

Enter the Form name using the keys on the keyboard. Tip: If a scanner is connected to the ZKDU, you may enter the Form name by scanning it in from a pre-printed barcode.

When the Form name is entered, press **ENTER** to continue. The form is now retrieved and active in the printer.

Printing Forms without Variables

If the form does not contain variables, the display line will prompt:

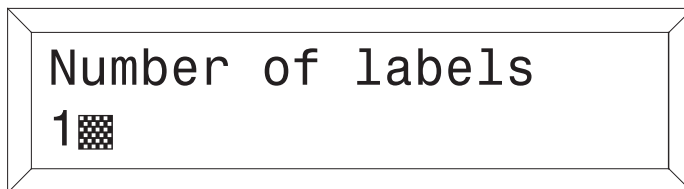

The default number of labels is always one (1). Entering a different number(s) will overwrite the default value. Non numeric values will be ignored with an error beep. This prompt is supplied automatically by the ZKDU.

Single Label - If one (1) label is desired, press **ENTER** to print that label.

Multiple Labels - If multiple labels are desired, enter the new quantity and press **ENTER** to print labels.

Exit a Form - Press the **EXIT** key at any time to return to the Forms screen, or press the **FORM** key to select another form.

Printing Forms with Variables

If the Form contains variables, the display line will display the 1st variable prompt (as programmed 'Total No. of Boxes'), i.e.:

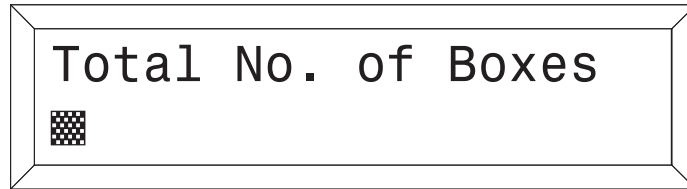

A rectangular frame containing the text "Total No. of Boxes" in a large, bold, sans-serif font. Below the text, there is a small square cursor icon consisting of a grid of dots.

Enter data at each variable prompt and press **ENTER**. The final prompt is:

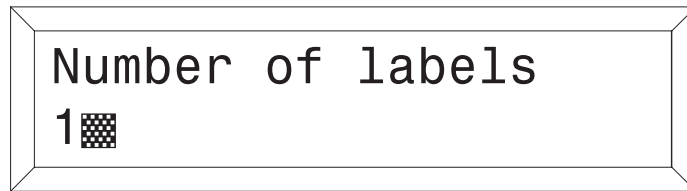

A rectangular frame containing the text "Number of labels" in a large, bold, sans-serif font. Below the text, the number "1" is displayed, followed by a small square cursor icon consisting of a grid of dots.

The default number of labels is always one (1). Entering a different number(s) will overwrite the default value. Non numeric values will be ignored with an error beep. This prompt is supplied automatically by the ZKDU.

Single Label - If one (1) label is desired, press **ENTER** to print that label.

Multiple Labels - If multiple labels are desired, enter the new quantity and press ENTER to print labels.

Exit a Form - Press the **EXIT** key at any time to return to the Forms screen, or press the **FORM** key to select another form.

Printing Forms with Consecutive Number Fields

If the Form contains a consecutive number (^SN - **Command:** Serialization Data) field, the system will automatically keep track of the next number sequence. Enter data at each variable prompt and press **ENTER**.

The first form finishing prompt is:

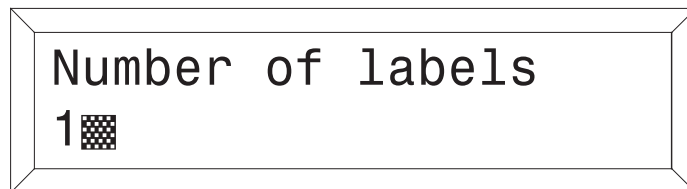

A rectangular frame containing the text "Number of labels" in a large, bold, sans-serif font. Below the text, the number "1" is displayed, followed by a small square cursor icon consisting of a grid of dots.

This value represents the **total** number of labels to print. The default number of labels is always one (1). Entering a different number(s) will overwrite the default value. Non numeric values will be ignored with an error beep. This prompt is supplied automatically by the ZKDU. (This varies from EPL mode operations which specifies label sets, not total labels to print).

The total number of labels (1st form finishing prompt) should be a multiple of the number of copies of each serial number (2nd form finishing prompt - the next step in the process).

The second form finishing prompt is:

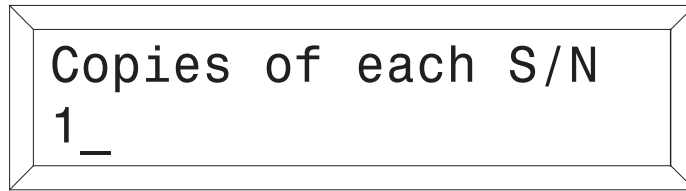

Copies of each S/N
1_

The default number of copies is always one (1). If one (1) copy is desired, press **ENTER** to print that label. Entering a different number(s) will overwrite the default value. Non numeric values will be ignored with an error beep. This prompt is supplied automatically by the ZKDU.

Edit Form Data - Once a Form has been activated, it will automatically indicate the last information keyed in. If you want to retain that information, press **ENTER**.

To Enter Data:

1. Enter the new input data, thereby overriding the previously entered input data for that variable, or
2. Press **ENTER** if the previously entered input data is correct, or
3. Use the orange **←** Backspace key or the **CLEAR** key to modify data. Enter new data at the cursor prompt and press **ENTER** to complete overwriting previous form data.

When you have finished editing and have printed the label, you will automatically return to the first variable prompt of this Form.

Exit a Form - Press the **EXIT** key at any time to return to the Forms screen, or press the **FORM** key to select another form.

Auxiliary Port

The ZKDU supports an additional data input peripheral device via a single auxiliary serial port.

Contents

The Auxiliary Port	34
Auxiliary Port Communication Configuration	34
ZKDU Pinout Configuration	34

The Auxiliary Port

The Auxiliary port is capable of supporting a single wedge device (barcode scanner, weight scale, 10-key pad, etc.). The key features are:

- Only receives input data for auxiliary device.
- It is only active during Form data entry operations.
- It is active in both EPL and ZPL Form data entry operations.
- Includes low current +5 volt DC to power wedge devices.
- The port is configured as a Data Terminal Equipment (DTE) port.

Auxiliary Port Communication Configuration

Auxiliary port communication settings:

- **Baud Rate:** 4800
- **Parity:** none
- **Data bits:** 8
- **Stop bits:** 1
- **Flow control:** Hardware
- **Data flow:** Input only

ZKDU Pinout Configuration

The Auxiliary port connector is a Female DB-9. Low current +5 volt DC is supplied on pin 9 of the auxiliary port to retain backward compatibility to the KDU classic.

PIN	NAME	DIRECTION
1	DCD	NOT USED
2	TXD	NOT USED
3	RXD	FROM AUX DEVICE
4	DTR	NOT USED
5	GND	
6	DSR	TO AUX DEVICE
7	RTS	NOT USED
8	CTS	TO AUX DEVICE
9	+5V (RI)	TO AUX DEVICE

The + 5 Volt DC power supplied to the ZKDU via the printer, draws 50 mA for the ZKDU. The remaining current is available to power peripheral devices attached to the ZKDU via the Auxiliary Port. The current available depends upon the Zebra label printer type attached to the port.

- Printers with ZPL allow 750 mA - 50 mA (ZKDU draw) = 700mA
- EPL only printer allow 250 mA - 50 mA (ZKDU draw) = 200mA

Dimensions

This section provides external ZKDU dimensions.

Contents

ZKDU External DimensionsZKDU	36
------------------------------------	----

ZKDU External DimensionsZKDU

